

MODE selector ①

Yellow colored positions are for Rhythm Pattern writing mode and the red positions are for programming or playing Rhythm track.

The MODE selector has 6 positions as shown below. In changing the modes be sure to have STOP condition.

1. PATTERN CLEAR

With this position the rhythm pattern which previously stored can be erased by pressing CLEAR button.

2. 1st PART

This position is for writing rhythm patterns.

3. 2nd PART

In combination with 1st Part this mode can be used for writing some rhythm patterns of 32 beats and 5/4, 7/4, etc....

4. MANUAL PLAY

This mode is for performance with manual rhythm selection.

5. RHYTHM TRACK PLAY

This mode is for performing the composed rhythms for entire song.

6. RHYTHM TRACK COMPOSE

This mode is for composing the rhythm for entire song.

CLEAR button ②

According to the MODE selector's positions this button works in the different ways as follows:

* MODE selected:

PATTERN CLEAR

Clears the rhythm patterns selected by BASIC RHYTHM, INTRO/FILL IN buttons and VARIATION switches under the STOP condition.

1st PART

2nd PART

Specifies the number of steps and simultaneously memorizes the position of PRE-SCALE selector while running.

RHYTHM TRACK COMPOSE

Clears the program selected by RHYTHM TRACK selector.

SYNC. JACK and switch ⑦

These are for connecting TR-808 with some Roland products (MC-4, CSQ-600 etc.) for sync, performance. When TR-808 is controlled by the other unit, set SYNC. IN/OUT switch to INPUT. And when TR-808 controls the other unit set this switch to OUTPUT. When the switch is set to INPUT, TR-808 cannot work by itself.

INSTRUMENT/TRACK selector ⑧

When MODE selector is set to 1st PART or 2nd PART, it serves as INSTRUMENT selector for writing rhythm pattern.

When MODE selector is set to RHYTHM TRACK PLAY or COMPOSE, this selects a RHYTHM TRACK.

AUTO FILL IN selector ⑨

FILL IN rhythm selected by INTRO/FILL IN button and I/F VARIATION switch is inserted at every measures specified by this selector.

This function is available only when MODE selector is set at MANUAL PLAY or COMPOSE. FILL IN can be inserted by pressing TAP button with this switch in MANUAL PLAY and TRACK COMPOSE.

I/F VARIATION switch ⑩

This Switch has the same function as BASIC VARIATION but has no AB position.

TAP button ⑪

When MODE selector is set at MANUAL PLAY or COMPOSE, this button inserts fill in rhythm selected by INTRO/FILL IN button and I/F VARIATION switch. With MODE selector positioned at 1st and 2nd PART, rhythms can be written by tapping this button.

BASIC VARIATION switch ⑬

Each BASIC RHYTHM 1-12 has two rhythms consisting of the same steps and pre-scale. In AB position, pattern A and B run alternately.

START/STOP button ⑫

This button is for starting or ending rhythm. In MODE selector operation, be sure to stop rhythm. In compose mode, press before the end of the last measure.

PRE-SCALE selector ⑭

This selects PRE-SCALE which determines how many steps there will be for each beat (a quarter note). While running, set the PRE-SCALE selector and push CLEAR button, and selected PRE-SCALE position can be memorized.

BASIC RHYTHM, INTRO/FILL IN button or STEP button ⑮

When MODE selector is set at MANUAL PLAY, RHYTHM TRACK PLAY, COMPOSE and PATTERN CLEAR these buttons are for selecting rhythm pattern. When MODE selector is set at 1st PART or 2nd PART these are for selecting rhythm pattern under the STOP condition. While rhythm running, these work as the STEP buttons. Under this condition the steps per measure can be specified by pressing this button while pressing CLEAR button.

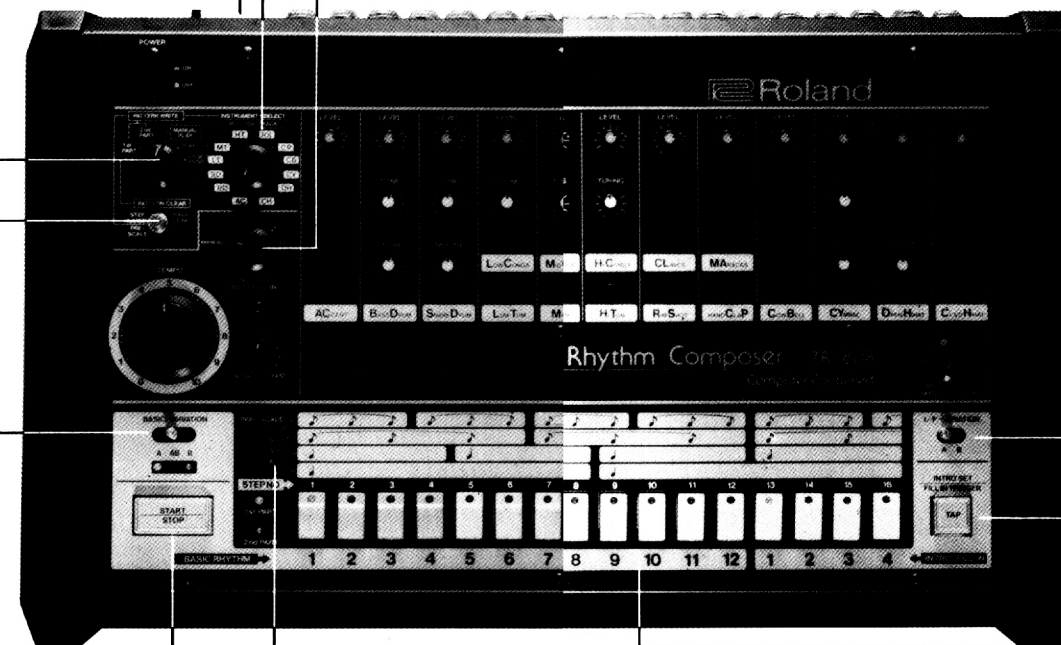

BASIC CONNECTION PROCEDURE

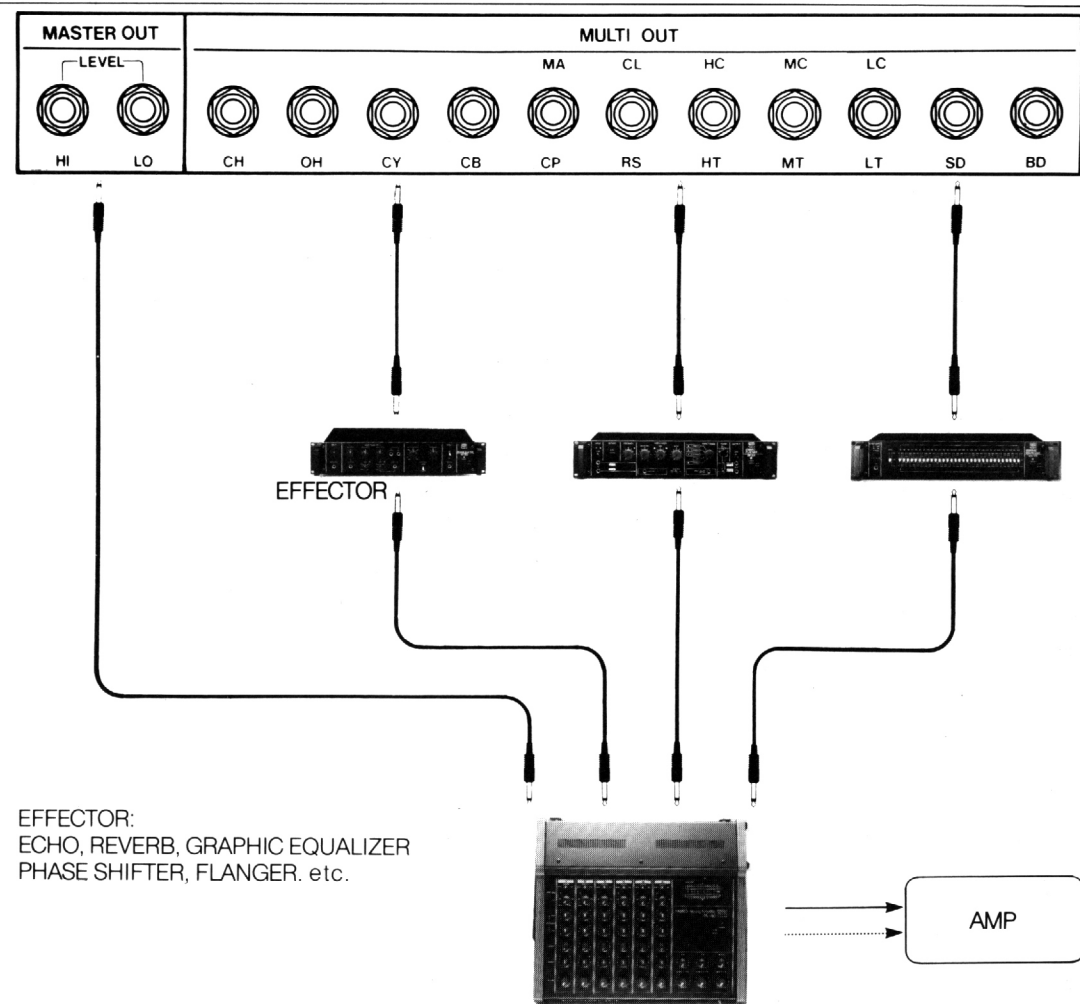

EFFECTOR:
ECHO, REVERB, GRAPHIC EQUALIZER
PHASE SHIFTER, FLANGER, etc.

1) Connect MASTER OUT (LEVEL HI or LOW) of TR-808 to your HiFi grade amplifier with provided cord.

2) Set MODE selector to MANUAL PLAY position.

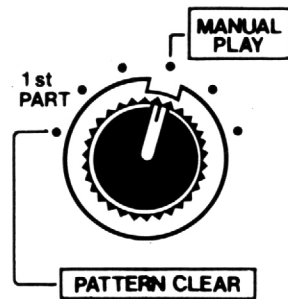

3) Connect power cable to AC outlet.

4) Turn POWER switch on.

5) Set SYNC Sw (BACK panel) to OUTPUT.

PLAYING RHYTHM PATTERNS

Let's play rhythm patterns. Some commonly used rhythm patterns have already been programmed in your TR-808.

1. Playing BASIC RHYTHM pattern.

1) Set MODE selector to MANUAL PLAY.

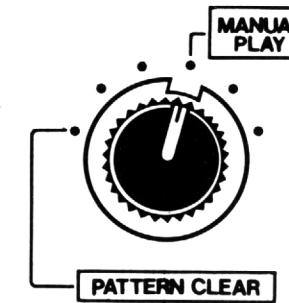

2) Set AUTO FILL IN selector to MANUAL.

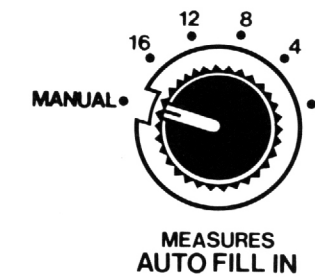

3) Select one of BASIC RHYTHM buttons. For example, push #3 and LED in #3 begins to flash.

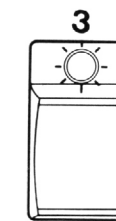

4) Set BASIC VARIATION switch to AB position. When this switch is at AB position the TR-808 will play the A and B alternately.

BASIC-VARIATION

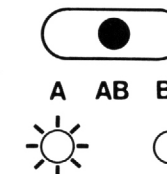

5) Push START/STOP button and confirm effects of the following controls.



(TEMPO, MASTER Vol, LEVEL or TONE control of each sound sources.)

6) Set BASIC VARIATION switch to A or B, then confirm the difference.

BASIC-VARIATION

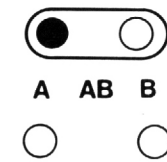

7) Push START/STOP button.

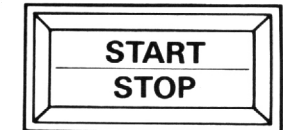

2. Playing FILL IN rhythm pattern.

1) Select one of INTRO/FILL IN rhythm patterns, for example push INTOR/FILL IN button #3.

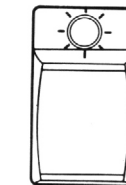

3

INTRO/FILL IN

2) Set I/F VARIATION switch to A.

I/F-VARIATION

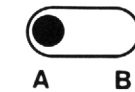

3) Push START/STOP button.

By pressing TAP button FILL IN rhythm pattern can replace the coming basic rhythm.



4) Set AUTO FILL IN selector to desired position. For example, set AUTO FILL IN selector to 4. FILL IN rhythm will be inserted.

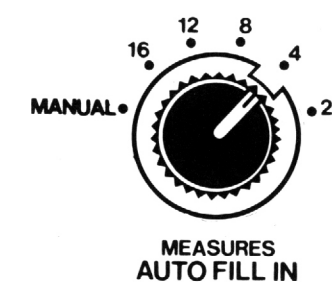

HOW TO WRITE RHYTHM PATTERNS

Rhythm patterns can be composed, modified and confirmed with LED's patterns.

1) Stop the rhythm, then set MODE selector ● to PATTERN-CLEAR.

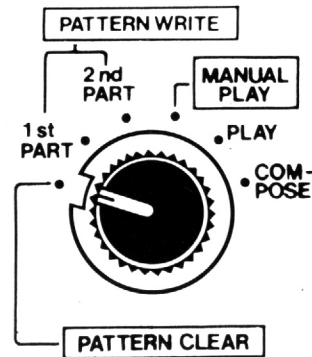

2) Push BASIC RHYTHM button #1, ●

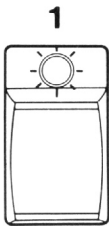

3) Set BASIC VARIATION switch ● to A.

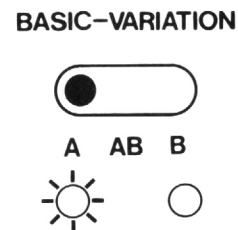

4) Clear the pattern by pressing CLEAR button ●

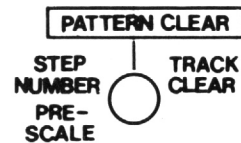

5) Set MODE selector ● to 1st PART.

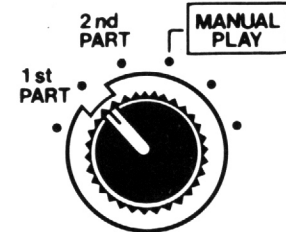

6) Push START/STOP button ●



7) Set PRE-SCALE selector ● to #3.

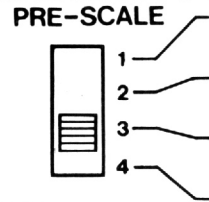

8) Push CLEAR button.

In this operation, pre-scale is memorized. Specify the desired step number by pressing STEP button while pressing CLEAR button ●. (When MODE selector is set to 1st PART or 2nd PART, BASIC RHYTHM and INTRO/FILL IN buttons work as STEP buttons.)

For example, by pressing STEP button #12 one measure is divided into 12 steps.

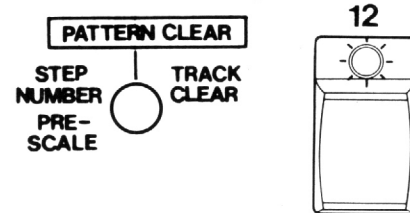

9) Again push CLEAR button ● then press STEP button.

So one measure is divided into 16 steps.

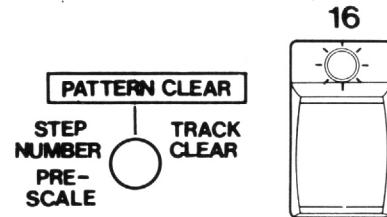

10) Set INSTRUMENT selector ● to BD (Bass Drum).

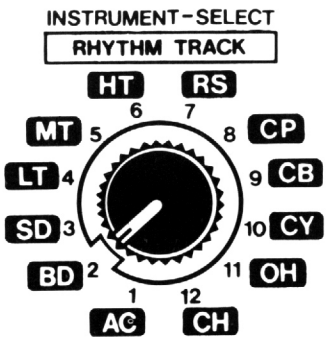

11) Push #1, 7, 11 and 15 of STEP button one by one according to program score #1.

•Rhythm score 1

•Program score 1

Step No.	1	2	3	4	5	6	7	8	9	10	11	12	13	14	15	16
BD																
SD																
CP																
OH																
CH																
AC																

HOW TO COMPOSE THE RHYTHM TRACKS

12) Push again when you want to erase above rhythm.

13) Write the other instruments with the same operation.

14) These rhythm patterns can also be written by Tapping.



15) Stop the rhythm.

Each of the 12 Tracks memorize up to 64 measures and these can be used separately or all together for a maximum Composition of 768 measures.

Compose on rhythm track #3 by using factory programmed BASIC RHYTHM patterns #3A, #4A, #5A and #6A.

1) Stop rhythm and set MODE selector ● to RHYTHM TRACK COMPOSE.

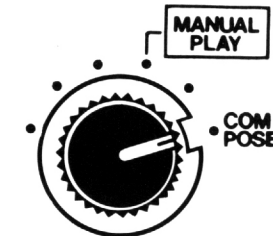

2) Set TRACK SELECTOR ● to #3.



3) Push CLEAR button. This clears memory bank #3, so you can compose on the bank.

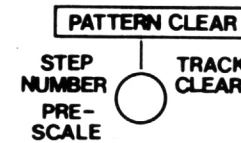

4) Set BASIC VARIATION switch to A.

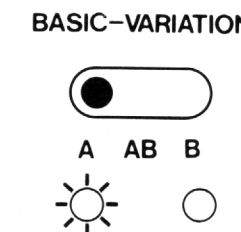

16) Set MODE selector ● to MANUAL PLAY.

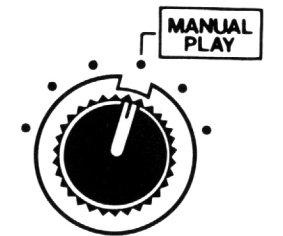

16) By using 2nd Part, 32beats can be programmed. Refer to owners manual for detail.

5) Select BASIC RHYTHM #3 for the first measure.

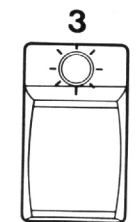

6) Push START/STOP button to start.



7) Change rhythm patterns in the same manner as MANUAL PLAY mode.

8) Push START/STOP button while the last measure is running.



9) Set MODE selector to RHYTHM TRACK PLAY.

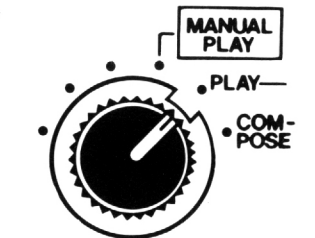

10) Push START/STOP button to start composed rhythm.

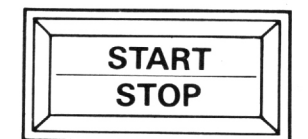

PLAYING RHYTHM TRACKS

Rock and Latin Rhythms have already been programmed for your reference.

1. Rock Rhythm Pattern.

1) Set MODE selector ● to RHYTHM TRACK PLAY.

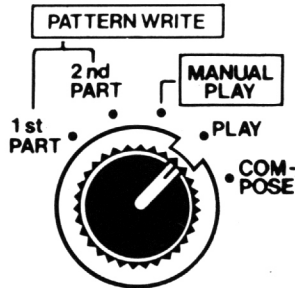

2) Set all VOICE selectors to lower position. In this case, L/M/H TOM, HAND CLAP and RIM SHOT are selected.

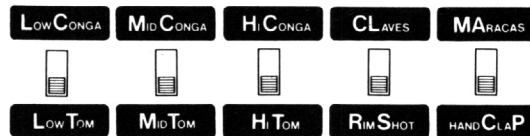

3) Set TRACK selector ● to #1.

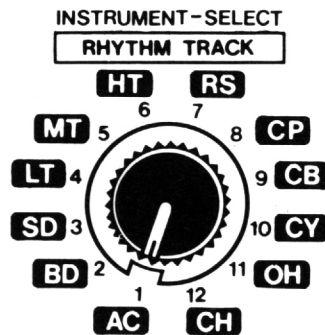

4) Set BASIC VARIATION switch ● and I/F VARIATION switch to A.

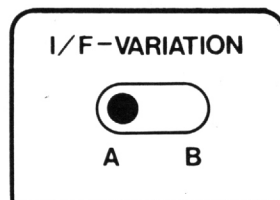
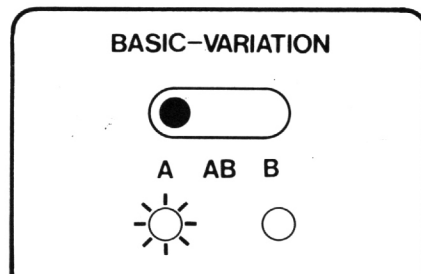

5) Push START/STOP button.



6) Stop the rhythm.

2. Latin Rhythm Pattern.

1) Set VOICE selectors to upper position except Handclap.



2) Set TRACK selector to #2.



3) Set BASIC VARIATION switch and I/F VARIATION switch to B.

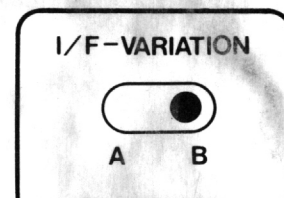
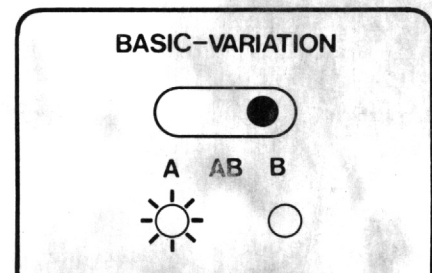

4) Push START/STOP button.

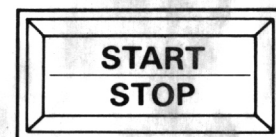

5) Stop the rhythm.